

Best Quality With Better Service













**SURGICAL
INSTRUMENTS
PRICE LIST**



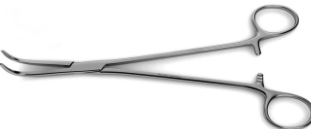













GENERAL ITEMS

1















S.No.	Product Name
1	Lotion Bowl 4"
2	Lotion Bowl 5"
3	Lotion Bowl 6"
4	BP Handle (No-3 and No-4)
5	Bandage Scissor
6	Artery Forceps 6" (Curved/Straight)
7	Artery Forceps 8" (Curved/Straight)
8	Artery Forceps 10" (Curved/Straight)
9	Artery Forceps 12" (Curved/Straight)
10	Anal Dialtor (Size-1,2,3,4,5,6)
11	Addison Forceps
12	Debakey Forceps (6 inch)
13	Debakey Forceps (8 inch)
14	Debakey Forceps (10 inch)

Picture





























S.No.	Product Name
15	Czerny Retractor (6 inch)
16	Czerny Retractor (8 inch)
17	Cuticle Scissors (3.5 inch)
18	Cuticle Scissors (4 inch)
19	Cheatele Forceps (10 inch)
20	Dressing Scissor 5" (Sharp+Blunt) (Curved/Straight)
21	Dressing Scissor 6" (Sharp+Blunt) (Curved/Straight)
22	Dressing Scissor 8" (Sharp+Blunt) (Curved/Straight)
23	Dressing Scissor (Blunt+Blunt) (Curved/Straight) (On order only)
24	Dressing Scissor 4" (Curved/Straight)
25	Dressing Scissor 5" (Curved/Straight)
26	Dressing Scissor 6" (Curved/Straight)
27	Dressing Scissor 8" (Curved/Straight)
28	Iris Scissor (3.5 inch)

Picture























S.No.	Product Name
29	Dissecting Forceps 4" (Toothed/Non toothed)
30	Dissecting Forceps 5" (Toothed/Non toothed)
31	Dissecting Forceps 6" (Toothed/Non toothed)
32	Dissecting Forceps 8" (Toothed/Non toothed)
33	Goniometer Plastic Finger
34	Goniometer Plastic Half
35	Goniometer Plastic Full 360°
36	Goniometer Steel Finger
37	Goniometer Steel Half
38	Goniometer Steel Full
39	Knee Hammer (Plastic)
40	Knee Hammer (Steel)
41	Iris Forceps
42	Mosquito Forceps 5" (Curved/Straight)

Picture















S.No.	Product Name
43	Metzenbaum Scissor 6'' (Curved/Straight)
44	Metzenbaum Scissor 8'' (Curved/Straight)
45	Mayo Scissors 6'' (Curved/Straight)
46	Mayo Scissors 8'' (Curved/Straight)
47	Needle Holder (6 inch)
48	Needle Holder (8 inch)
49	Needle Holder (10 inch)
50	Post Mortem Set
51	Probe With Eye
52	Right Angle Forceps (6 inch)
53	Right Angle Forceps (8 inch)
54	Right Angle Forceps (10 inch)
55	Suture Scissor
56	Tenaculum Forceps





Picture















S.No.	Product Name
57	Towel Clip
58	Towel Forcep (5 inch)
59	Towel Forcep (6 inch)
60	Satinsky Clamp
61	Laryngoscope (child)
62	Laryngoscope (Adult)
63	Laryngoscope Bulb
64	Laryngeal Mirror















Picture









GYNAECOLOGY ITEMS





65	Cusco Speculum
66	Green Armytage Forceps
67	Hegar Dialtor (Magnetic)
68	Hegar Dialtor (Anti-Magnetic)
69	Hegar Dialtor (set of 10 with pouch)

S.No.	Product Name
70	Hysterectomy Clamp
71	Ovum Forcep
72	D & C Set
73	Sponge Holder (6 inch)
74	Sponge Holder (8 inch)
75	Sponge Holder (10 inch)
76	Rampléy Sponge Holder 8"
77	Rampléy Sponge Holder 10"
78	Umbical Cord Scissor
79	Uterine Curette
80	Uterine Sound
81	Sim Speculum Magnetic
82	Sim Speculum Anti-Magnetic
83	Vaginal Currette









Picture



















S.No.	Product Name
84	Vaginal Wall Retractor
85	Wringley or Delivery Forceps Set
86	Grave Speculum
87	Tracheal Dialattor
88	Urethral Dialattor Set of 10

Picture





INTESTINAL & RECTUM INSTRUMENTS

89	Allis Tissue (6 inch)
90	Allis Tissue (8 inch)
91	Babcock Forceps (6 inch)
92	Babcock Forceps (8 inch)
93	Intestinal Clamp
94	Kocher Intestinal Forceps 6" (Curved/Straight)
95	Kocher Intestinal Forceps 8" (Curved/Straight)
96	NSV Set

S.No.	Product Name	Picture
97	Yankauer Suction	
98	Pile Gun Set	
99	Proctoscope Black Handle	
100	Proctoscope Brass	

MOUTH GAGS

101	Mouth Gag Davis	
102	Mouth Gag Doyens	
103	Mouth Gag HISTER	
104	Vetinary Mouth Gag	

NEEDLES & CANNULAS

105	Bone Marrow Needle (Size-14,16,18,20)	
106	EB Currette	
107	HSG Cannula Without Lock	
108	HSG Cannula With Lock	

S.No.	Product Name
109	Jamshidi Needle
110	Suction Tips
111	MTP Set
112	Suction Cannula
113	Abraham Needle
114	Liver Biopsy Needle







Picture

















ORTHOPADICS

115	Bone Cutter Single Action /Forceps Angled
116	Amputation Saw
117	Bone Cutting Forceps Angular
118	Bone Cutter Double Action
119	Bone File and Rasp
120	Bone Holding Forceps
121	Chisel











S.No.	Product Name
122	Electric Plaster Cutter
123	Electric Bone Cutter
124	Plaster Cutting Saw (Angle)
125	Plaster Cutting Saw (Big)
126	Gigli Saw Wire (Pack of 25)
127	K Wire (Pack of 10)
128	Hohmann Retractor
129	Hudson Brase
130	Mallet Fluted Handle
131	Osteotome Fibre
132	Plate Bender













Picture











RETRACTORS

133	Skin Grafting Handle
134	Balfour Retractor

S.No.	Product Name
135	Deavers Retractor
136	Doyens Retractor (Small)
137	Doyens Retractor (Large)
138	Kelly Retractor (Arter)
139	Kelly Retractor (PPIUCD)
140	Langenbeck Retractor (Small)
141	Langenbeck Retractor (Large)
142	Mastoid Retractor
143	Morris Retractor
144	Self Retaining Retractor
145	S-Shaped Retractor
146	Cat Paw Retractor
147	Nasal Speculum Killian

Picture













S.No.	Product Name
148	Lucs Forceps
149	Aural Forcep
150	Punch Biopsy Forcep
151	Kerrison Punch
152	Hartmann Nasal Dressing Forceps
153	Ophthalmoscope
154	Tongue Depressor (Steel)
155	Nasal Speculum Thudikan
156	Tunning Fork
157	Magil Forceps
158	Jabson Probe
159	ENT Set

Picture











